

# RDT940F902 - Configurable controllers

ENGLISH

## IMPORTANT

Read this document carefully before installing and using the device and follow all the additional information; keep this document close to the device for future consultations. For further information consult the hardware manual.

The device must be disposed according to the local legislation about the collection for electrical and electronic equipment.

## 1 INTRODUCTION

**1.1 Introduction**  
RDT940F902 is a range of configurable controllers for applications in refrigeration and air conditioning sectors. The controllers have a considerable number of inputs and outputs; they allow to realize a flexible, modular and expandable control devices network. The variety of available communication ports (RS-485, CAN, USB and Ethernet) and supported communication protocols make easier the integration of the devices in systems. For information on the use of the BACnet communication protocol please consult the PICS.

The actual version implements a BACnet® standardized device profile B-ASC, which doesn't require the managing of Scheduler and Calendar objects, instead required for the B-AAC profile.

## 2 DESCRIPTION

**Description**  
The following drawing shows the aspect of the devices.

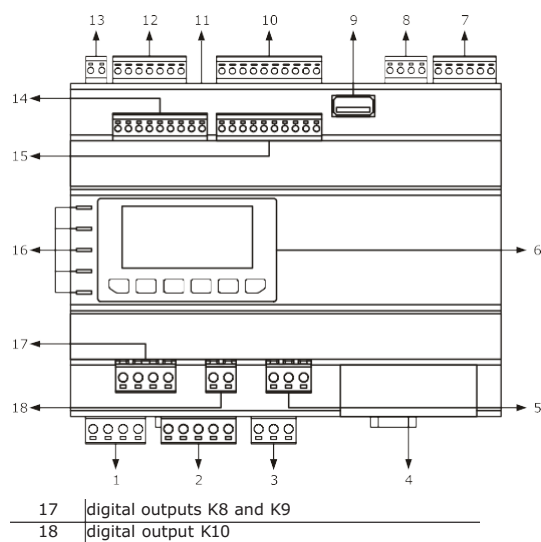

The following chart shows the meaning of the parts of the devices.

Part	Meaning
1	digital outputs K1 and K2
2	digital outputs K3, K4, K5 and K6
3	digital output K7
4	MODBUS TCP, Web Server Ethernet port
5	digital output K11
6	display and keyboard (not available in the blind versions)
7	digital inputs 1... 5
8	analog outputs 1... 3
9	USB port
10	analog inputs 1... 6
11	micro-switch to plug in the CANBUS CAN port line termination, the MODBUS master/slave RS-485 port line termination and the MODBUS slave RS-485 port line termination
12	MODBUS slave RS-485 port, MODBUS master/slave RS-485 port and CANBUS CAN port
13	power supply
14	analog outputs 7... 10 and analog outputs 4... 6
15	digital inputs 6... 13
16	signalling LEDs
17	digital outputs K8 and K9
18	digital output K10

## 3 SIZE AND INSTALLATION

**3.1 Size**  
The following drawing shows the size of the devices (8 DIN modules); size is in mm (in).

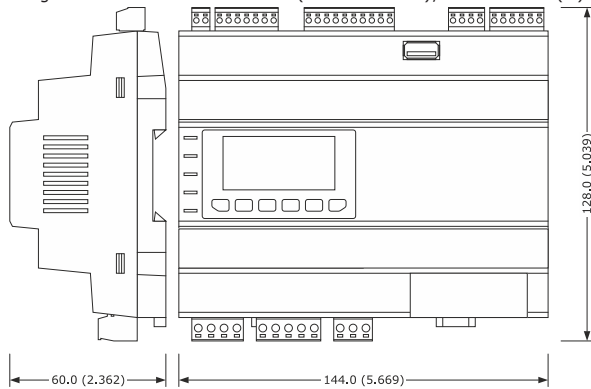

## 3.2 Installation

Installation is on DIN rail 35.0 x 7.5 mm (1.377 x 0.295 in) or 35.0 x 15.0 mm (1.377 x 0.590 in), into a switch-board.

To install the devices operate as shown in the following drawing.

To remove the devices remove possible extractable screw terminal blocks plugged at the bottom first, then operate on the DIN rail clips with a screwdriver as shown in the following drawing.

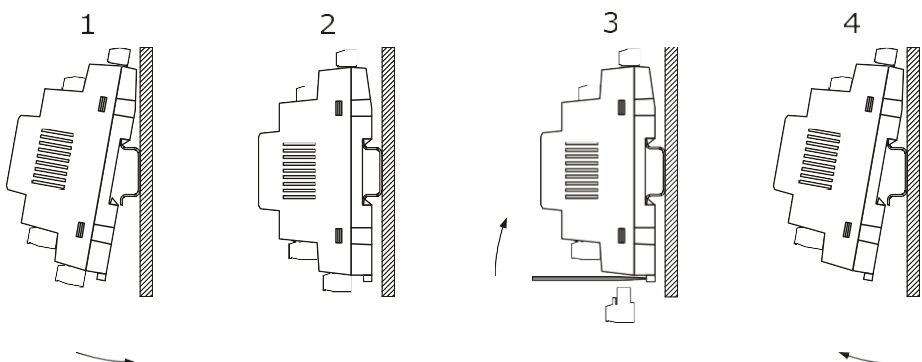

To install the devices again press the DIN rail clips to the end first.

## 3.3 Additional information for the installation

- make sure the working conditions of the device (operating temperature, operating humidity, etc.) are in the limits indicated; look at chapter "TECHNICAL DATA"

do not install the device close to heating sources (heaters, hot air ducts, etc.), devices having big magnets (big speakers, etc.), locations subject to direct sunlight, rain, humidity, dust, mechanical vibrations or bumps

- according to the safety legislation, the protection against possible contacts with the electrical parts must be ensured by a correct installation of the device; all the parts which ensure the protection must be fixed so that you can not remove them if not by using a tool.

## 4 ELECTRICAL CONNECTION

### 4.1 Connectors

The following drawing shows the connectors of the devices.

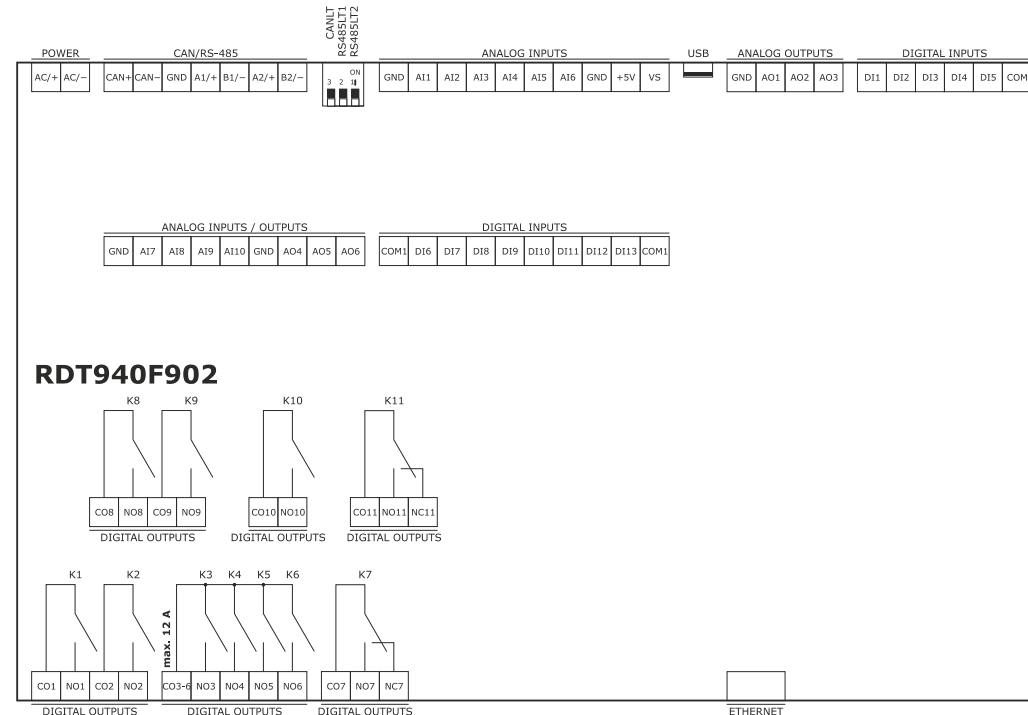

### 4.2 Meaning of connectors

The following charts show the meaning of the connectors of the devices.

For further information look at chapter "TECHNICAL DATA".

### POWER

Power supply device (24 VAC/DC not isolated). If the device is powered in direct current, it will be necessary to respect the polarity of the power supply voltage. If the device is connected to a devices network, it will be necessary:

- the power supply of the devices making the network is galvanically isolated one another
- the phase supplying the device is the same supplying all the devices making the network.

Part	Meaning
AC/+	power supply device: - if the device is powered in alternate current, connect the phase - if the device is powered in direct current, connect the positive pole
AC/-	power supply device: - if the device is powered in alternate current, connect the neutral - if the device is powered in direct current, connect the negative pole

### ANALOG INPUTS

Part	Meaning
GND	ground analog inputs
AI1	analog input 1, which can be set via configuration parameter for PTC, NTC, Pt 1000, Ni 1000 probes, 0-20 mA, 4-20 mA, 0-5 V rat. or 0-10 V transducers
AI2	analog input 2, which can be set via configuration parameter for PTC, NTC, Pt 1000, Ni 1000 probes, 0-20 mA, 4-20 mA, 0-5 V rat. or 0-10 V transducers
AI3	analog input 3, which can be set via configuration parameter for PTC, NTC, Pt 1000, Ni 1000 probes, 0-20 mA, 4-20 mA, 0-5 V rat. or 0-10 V transducers
AI4	analog input 4, which can be set via configuration parameter for PTC, NTC, Pt 1000 or Ni 1000 probes
AI5	analog input 5, which can be set via configuration parameter for PTC, NTC, Pt 1000 or Ni 1000 probes
AI6	analog input 6, which can be set via configuration parameter for PTC, NTC, Pt 1000 or Ni 1000 probes
GND	ground analog inputs
+5V	power supply 0-5 V ratiometric transducers (5 VDC)

### DIGITAL INPUTS

Part	Meaning
DI1	digital input 1 (24 VAC/DC, 50/60 Hz or 2 KHz optoisolated)
DI2	digital input 2 (24 VAC/DC, 50/60 Hz or 2 KHz optoisolated)
DI3	digital input 3 (24 VAC/DC, 50/60 Hz optoisolated)
DI4	digital input 4 (24 VAC/DC, 50/60 Hz optoisolated)
DI5	digital input 5 (24 VAC/DC, 50/60 Hz optoisolated)
COM	common digital inputs

### DIGITAL INPUTS

Part	Meaning
COM1	common digital inputs
DI6	digital input 6 (24 VAC/DC, 50/60 Hz optoisolated)
DI7	digital input 7 (24 VAC/DC, 50/60 Hz optoisolated)
DI8	digital input 8 (24 VAC/DC, 50/60 Hz optoisolated)
DI9	digital input 9 (24 VAC/DC, 50/60 Hz optoisolated)
DI10	digital input 10 (24 VAC/DC, 50/60 Hz optoisolated)
DI11	digital input 11 (24 VAC/DC, 50/60 Hz optoisolated)
DI12	digital input 12 (24 VAC/DC, 50/60 Hz optoisolated)
DI13	digital input 13 (24 VAC/DC, 50/60 Hz optoisolated)
COM	common digital inputs

### ANALOG OUTPUTS

Part	Meaning
GND	ground analog outputs
AO1	analog output 1, which can be set via configuration parameter for PWM or 0-10 V
AO2	analog output 2, which can be set via configuration parameter for PWM or 0-10 V
AO3	analog output 3, which can be set via configuration parameter for 0-20 mA, 4-20 mA or 0-10 V

VS power supply 0-20 mA, 4-20 mA and 0-10 V transducers (12 VDC)

### ANALOG INPUTS / OUTPUTS

Part	Meaning
GND	ground analog inputs and outputs
AI7	analog input 7, which can be set via configuration parameter for PTC, NTC, Pt 1000, Ni 1000 probes, 0-20 mA, 4-20 mA, 0-5 V rat. or 0-10 V transducers
AI8	analog input 8, which can be set via configuration parameter for PTC, NTC, Pt 1000, Ni 1000 probes, 0-20 mA, 4-20 mA, 0-5 V rat. or 0-10 V transducers
AI9	analog input 9, which can be set via configuration parameter for PTC, NTC, Pt 1000, Ni 1000 probes, 0-20 mA, 4-20 mA, 0-5 V rat. or 0-10 V transducers
AI10	analog input 4, which can be set via configuration parameter for PTC, NTC, Pt 1000 or Ni 1000 probes
GND	ground analog inputs and outputs
AO4	analog output 4, which can be set via configuration parameter for 0-20 mA, 4-20 mA or 0-10 V
AO5	analog output 5, for 0-10 V
AO6	analog output 6, for 0-10 V

### DIGITAL OUTPUTS

Part	Meaning
CO1	common digital output 1
NO1	normally open contact digital output 1 according to the model: - 3 res. A @ 250 VAC electromechanical relay - 24 VAC/DC, 600 mA max. command for solid state relay
CO2	common digital output 2
NO2	normally open contact digital output 2 according to the model: - 3 res. A @ 250 VAC electromechanical relay - 24 VAC/DC, 600 mA max. command for solid state relay
CO3-6	common digital outputs 3... 6
NO3	normally open contact digital output 3 (3 res. A @ 250 VAC electromechanical relay)
NO4	normally open contact digital output 4 (3 res. A @ 250 VAC electromechanical relay)
NO5	normally open contact digital output 5 (3 res. A @ 250 VAC electromechanical relay)
NO6	normally open contact digital output 6 (3 res. A @ 250 VAC electromechanical relay)
CO7	common digital output 7
NO7	normally open contact digital output 7 (3 res. A @ 250 VAC electromechanical relay)

NC7	normally closed contact digital output 7
CO8	common digital output 8
NO8	normally open contact digital output 8 according to the model: - 3 res. A @ 250 VAC electromechanical relay - 24 VAC/DC, 600 mA max. command for solid state relay
CO9	common digital output 9
NO9	normally open contact digital output 9 according to the model: - 3 res. A @ 250 VAC electromechanical relay - 24 VAC/DC, 600 mA max. command for solid state relay
CO10	common digital outputs 10
NO10	normally open contact digital output 10 (3 res. A @ 250 VAC electromechanical relay)
CO11	common digital output 11
NO11	normally open contact digital output 11 (3 res. A @ 250 VAC electromechanical relay)
NC11	normally closed contact digital output 11

### CAN/RS-485

MODBUS slave RS-485 port, MODBUS master/slave RS-485 port and CAN CANBUS port.

Part	Meaning
CAN+	positive pole CANBUS CAN port
CAN-	negative pole CANBUS CAN port
GND	ground MODBUS slave RS-485 port, MODBUS master/slave RS-485 port and CAN CANBUS port
A1/+	positive pole MODBUS master/slave RS-485 port
B1/-	negative pole MODBUS master/slave RS-485 port
A2/+	positive pole MODBUS slave RS-485 port
B2/-	negative pole MODBUS slave RS-485 port

### USB

USB port.

### ETHERNET

MODBUS TCP, Web Server Ethernet port.

### 4.3 Plugging in the CANBUS CAN port line termination

To plug in the CANBUS CAN port line termination, position micro-switch 3 on position ON.

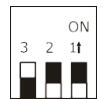

### 4.4 Plugging in the MODBUS master/slave RS-485 port line termination

To plug in the MODBUS master/slave RS-485 port line termination, position micro-switch 2 on position ON.

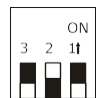

### 4.5 Plugging in the MODBUS slave RS-485 port line termination

To plug in the MODBUS slave RS-485 port line termination, position micro-switch 1 on position ON.

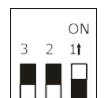

### 4.6 Polarizing the MODBUS master/slave RS-485 port

The polarization of the MODBUS master/slave RS-485 port can be set via configuration parameter.

### 4.7 Polarizing the MODBUS slave RS-485 port

The devices are not able to polarize the MODBUS slave RS-485 port; the polarization must be done by another device.

### 4.8 Additional information for electrical connection

- do not operate on the terminal blocks of the device using electrical or pneumatic screwdrivers
- if the device has been moved from a cold location to a warm one, the humidity could condense on the inside; wait about an hour before supplying it
- make sure the power supply voltage, the electrical frequency and the electrical power of the device correspond to those of the local power supply; look at chapter "TECHNICAL DATA"
- disconnect the power supply of the device before servicing it

- connect the device to a RS-485 devices network using a twisted pair
- connect the device to a CAN devices network using a twisted pair
- position the power cables as far away as possible from the signal cables
- do not use the device as safety device
- for the repairs and for information about the device please contact the Sauter sales network.

## 5 SIGNALINGS

5.1 LED	Signalings Meaning
<b>ON</b>	LED power supply if it is lit, the device will be powered if it is out, the device will not be powered
<b>RUN</b>	LED run if it is lit, the application software will be compiled and running in <i>release</i> modality if it flashes slowly, the application software will be compiled and running in <i>debug</i> modality if it flashes quickly, the application software will be compiled, running in <i>debug</i> modality and stopped in a breakpoint if it is out: - the device will not be compatible with the application software - the device will not be enabled to work with the <i>special ABL</i> (Application Block Libraries)
<b>Δ</b>	LED system alarm if it is lit, an alarm system not resettable via application software will be running if it flashes slowly, a system alarm with automatic reset will be running if it flashes very slowly, an access to the external FLASH memory will be running if it flashes quickly, a system alarm with manual reset will be running if it is out, no alarm system will be running
<b>CAN</b>	LED CANBUS CAN communication if it is lit, the device will be configured to communicate via CANBUS CAN with another device but the communication will not have been set up if it flashes slowly, the CANBUS CAN communication will have been set up but it will not be completely correct if it flashes quickly, the CANBUS CAN communication will have been set up and will be correct if it is out, no CANBUS CAN communication will be running
<b>L1</b>	LED auxiliary

## 6 TECHNICAL DATA

- 6.1 Technical data**  
**Purpose of control:** operating control device.  
**Construction of control:** incorporated electronic device.  
**Box:** self-extinguishing grey.  
**Heat and fire resistance category:** D.  
**Size:** 144.0 x 128.0 x 60.0 mm (5.669 x 5.039 x 2.362 in; W x H x D); 8 DIN modules.  
 Size refers to the device with the extractable screw terminal blocks properly plugged.  
**Method of mounting control:** on DIN rail 35.0 x 7.5 mm (1.377 x 0.295 in) or 35.0 x 15.0 mm (1.377 x 0.590 in).  
**Degree of protection:**  
 - IP20 on the whole  
 - IP40 the front.  
**Connections:**  
 - only male removable screw connection terminal blocks with pitch 3.5 mm (0.137 in) for conductors up to 1.5 mm<sup>2</sup> (0.0028 in<sup>2</sup>): power supply, analog inputs, digital inputs, analog outputs, MODBUS slave RS-485 port, MODBUS master/slave RS-485 port and CANBUS CAN port  
 - only male removable screw connection terminal blocks with pitch 5.0 mm (0.196 in) for conductors up to 2.5 mm<sup>2</sup> (0.0038 in<sup>2</sup>): digital outputs  
 - A type USB connector: USB port  
 - RJ45 Ftelephone connector: MODBUS TCP, Web Server Ethernet port.
- The maximum lengths allowed for the connecting cables are the following:
- power supply: 100 m (328 ft)
  - analog inputs: 100 m (328 ft)
  - power supply transducers: 100 m (328 ft)

- digital inputs: 100 m (328 ft)
- PWM analog outputs: 1 m (3.280 ft)
- 0-20 mA, 4-20 mA and 0-10 V analog outputs: 100 m (328 ft)
- digital outputs (electromechanical relays): 100 m (328 ft)
- digital outputs (command for solid state relays): 100 m (328 ft)
- MODBUS slave RS-485 port and MODBUS master/slave RS-485 port: 1,000 m (3,280 ft); also look at *MODBUS specifications and implementation guides* manual available on <http://www.modbus.org/specs.php>
- CANBUS CAN port:
  - 1,000 m (3,280 ft) with baud rate 20,000 baud
  - 500 m (1,640 ft) with baud rate 50,000 baud
  - 250 m (820 ft) with baud rate 125,000 baud
  - 50 m (164 ft) with baud rate 500,000 baud
 according to the factory setting the device automatically detects the baud rate of the other elements making the network, on condition that it is one of those listed before; on afterwards set manually the baud rate to the same value of that of the other elements
- USB port: 1 m (3.280 ft).

To wire the device one suggests using the connecting kit CJAV35 (to order separately): only female removable screw connection terminal blocks with pitch 3.5 mm (0.137 in) for conductors up to 1.5 mm<sup>2</sup> (0.0028 in<sup>2</sup>) and only female removable screw connection terminal blocks with pitch 5.0 mm (0.196 in) for conductors up to 2.5 mm<sup>2</sup> (0.0038 in<sup>2</sup>).

To program the device one suggests using the connecting cables 0810500018 or 0810500020 (to order separately): the cable 0810500018 is 2.0 m (6.561 ft) long, the cable 0810500020 is 0.5 m (1.640 ft) long.

### Operating temperature:

- from -10 to 55 °C (from 14 to 131 °F) for the built-in versions
- from -20 to 55 °C (from -4 to 131 °F) for the blind versions.

**Storage temperature:** from -25 to 70 °C (from -13 to 158 °F).

**Operating humidity:** from 10 to 90% of relative humidity not condensing.

**Control pollution situation:** 2.

### Environmental conformity:

- RoHS 2011/65/CE
- WEEE 2012/19/UE
- REACH regulation (CE) n. 1907/2006.

### EMC conformity:

- EN 60730-1
- IEC 60730-1.

### Power supply:

- 24 VAC (+10%, -15%), 50/60 Hz (±3 Hz), 20 VA max. not isolated
  - 20... 40 VDC, 12 W max. not isolated
- supplied by a class 2 circuit.  
 Protect the power supply with a 2 A-T 250 V fuse.

If the device is powered in direct current, it will be necessary to respect the polarity of the power supply voltage.

**Rated impulse voltage:** 4 KV.

**Overvoltage category:** III.

**Class and structure of software:** A.

**Real time clock:** incorporated (with lithium primary battery).  
 Battery range in absence of power supply: 5 years @ 25 °C (77 °F).

Drift: 30 s/month @ 25 °C (77 °F).

**Analog inputs:** 10 inputs:

- 4 which can be set via configuration parameter for PTC, NTC, Pt 1000 or Ni 1000 probes
- 6 which can be set via configuration parameter for PTC, NTC, Pt 1000, Ni 1000 probes, 0-20 mA, 4-20 mA, 0-5 V ratiometric or 0-10 V transducers.

Power supply 0-5 V ratiometric transducers: 5 VDC (+0 %, -12 %), 60 mA max.

Power supply 0-20 mA, 4-20 mA and 0-10 V transducers: 12 VDC (±10 %), 120 mA max.

The maximum current which can be supplied on the whole from the two power supply is 120 mA.

**PTC analog inputs (990 @ 25 °C, 77 °F)**

Kind of sensor: KTY 81-121.  
 Working range: from -50 to 150 °C (from -58 to 302 °F).

Accuracy: ±0.5 % of the full scale.  
 Resolution: 0.1 °C.  
 Conversion time: 100 ms.  
 Protection: none.

**NTC analog inputs (10 K @ 25 °C, 77 °F)**

Kind of sensor: B3435.  
 Working range: from -40 to 120 °C (from -58 to 248 °F).

Accuracy: - ±0.5 % of the full scale  
 from -40 to 100 °C  
 - ±1 °C from -50 to -40 °C  
 and from 100 to 120 °C.

Resolution: 0.1 °C.  
 Conversion time: 100 ms.  
 Protection: none.

**NTC analog inputs (10 K @ 25 °C, 77 °F)**

Kind of sensor: NTC type 2.  
 Working range: from -40 to 86 °C (from -40 to 186 °F).

Accuracy: ±1 °C.  
 Resolution: 0.1 °C.  
 Conversion time: 100 ms.  
 Protection: none.

**NTC analog inputs (10 K @ 25 °C, 77 °F)**

Kind of sensor: NTC type 3.  
 Working range: from -40 to 86 °C (from -40 to 186 °F).

Accuracy: ±1 °C  
 Resolution: 0.1 °C.  
 Conversion time: 100 ms.  
 Protection: none.

**Pt 1000 analog inputs (1 K @ 0 °C, 32 °F)**

Working range: from -100 to 400 °C (from -148 to 752 °F).

Accuracy: - ±0.5 % of the full scale  
 from -100 to 200 °C  
 - ±2 °C from 200 to -400 °C.

Resolution: 0.1 °C.  
 Conversion time: 100 ms.  
 Protection: none.

**Ni 1000 analog inputs (1 K @ 0 °C, 32 °F)**

Working range: from -50 to 260 °C (from -50 to 500 °F).

Accuracy: - ±0.5 % of the full scale  
 from -50 to 250 °C.

Resolution: 0.1 °C.  
 Conversion time: 100 ms.  
 Protection: none.

**0-20 mA and 4-20 mA analog inputs**

Input resistance: 200 .  
 Accuracy: ±0.5 % of the full scale.  
 Resolution: 0.01 mA.  
 Conversion time: 100 ms.  
 Protection: none; the maximum current allowed on each input is 25 mA.

**0-5 V ratiometric and 0-10 V analog inputs**

Input resistance: 10 K .  
 Accuracy: ±0.5 % of the full scale.  
 Resolution: 0.01 V.  
 Conversion time: 100 ms.  
 Protection: none.

**Digital inputs:** 13 inputs:

- 2 at 24 VAC/DC, 50/60 Hz or 2 KHz optoisolated
- 11 at 24 VAC/DC, 50/60 Hz.

**24 VAC/DC, 50/60 Hz digital inputs**

Power supply: - 24 VAC (±15 %), 50/60 Hz  
 (±3 Hz)  
 - 24 VDC (+66 %, -16 %).

Input resistance: 10 K .  
 Protection: none.

**24 VAC/DC, 2 KHz digital inputs**

Power supply: - 24 VAC (±15 %), 50/60 Hz  
 (±3 Hz)  
 - 24 VDC (+66 %, -16 %).

Input resistance: 10 K .  
 Protection: none.

**Analog outputs:** 6 outputs:

- 2 for 0-10 V
- 2 which can be set via configuration parameter for PWM or 0-10 V
- 2 which can be set via configuration parameter for 0-20 mA, 4-20 mA or 0-10 V.

**PWM analog outputs**

Power supply: 10 VDC (+16 %, -25 %), 10 mA max.  
 Frequency: 0... 2 KHz.  
 Duty: 0... 100 %.  
 Protection: none.

**0-20 mA and 4-20 mA analog outputs**

Input resistance: 40... 300 .  
 Accuracy: ±3 % of the full scale.  
 Resolution: 0.05 mA.  
 Conversion time: 1 s.  
 Protection: none.

**0-10 V analog outputs**

Input resistance: 1 K .  
 Accuracy: ±3 % of the full scale.  
 Resolution: - +2 %, -5 % of the full scale  
 for loads having impedance  
 from 1 to 5 K  
 - ±2 % of the full scale for  
 loads having impedance  
 > 5 K .

**Digital outputs:** 11 outputs:

- according to the model:
  - nine 3 res. A @ 250 VAC SPST electromechanical relays (K1... K6 and K8... K10)
  - four 24 VAC/DC, 600 mA max. commands for solid state relay (K1, K2, K8 and K9) and five 3 res. A @ 250 VAC SPST electromechanical relays (K3... K6 and K10)
  - two 3 res. A @ 250 VAC SPDT electromechanical relay (K7 and K11).

The device ensures a double insulation among each connector of the digital outputs and the remaining parts of the device.

**Type 1 or type 2 actions:** type 1.

**Additional features of type 1 or type 2 action:** C.

**Displays:** according to the model:

- none (blind version)
- 4+4 digits custom display (built-in LED version)
- 128 x 64 pixel single colour LCD graphic display (built-in LCD version).

**Communication ports:** 5 ports:

- 1 RS-485 port with MODBUS slave communication protocol
- 1 RS-485 port with MODBUS master/slave, BACnet MS/TP communication protocol
- 1 CAN port with CANBUS communication protocol
- 1 USB port
- 1 Ethernet port with MODBUS TCP, Web Server, BACnet IP communication protocol.

The actual version implements a BACnet® standardized device profile B-ASC, which doesn't require the managing of Scheduler and Calendar objects, instead required for the B-AAC profile.